

SnapLED 150

Reliability and robustness

SnapLED 150 cold clinching technology provides automotive exterior applications with unique benefits. It has superior reliability and better thermal behavior compared to surface mount solutions. SnapLED 150 LEDs enable a three dimensional solution that make it easier to manufacture and lower system costs compared to flex foil solutions — making SnapLED the preferred solution for dimensional designs. SnapLED 150 is AEC-Q101D qualified.

SnapLED 150 is available in the following color wavelength:

- Red Orange (615nm)



FEATURES AND BENEFITS

- Higher drive current capability for increased flux performance
- Low thermal resistance for better hot lumen performance
- AEC-Q101D qualified

PRIMARY APPLICATIONS

- Mirror/Side Repeater
- Stop/Tail
- CHMSL

Table of Contents

General Product Information	2
Product Test Conditions	2
Part Number Nomenclature	2
Environmental Compliance	2
Performance Characteristics	3
Product Selection Guide	3
Optical Characteristics	3
Electrical Characteristics	3
Absolute Ratings	4
Characteristic Curves	4
Spectral Power Distribution Characteristics	4
Light Output Characteristics	5
Forward Current Characteristics	6
Radiation Pattern Characteristics	7
Operating Limits Characteristics	8
Product Bin and Labeling Definitions	9
Designing with SnapLED	9
Decoding Product Bin Labeling	9
Luminous Flux Bins	9
Color Codes	10
Forward Voltage Bins	10
Mechanical Dimensions	11
Thermal Resistance Characteristics	12
Packaging Information	13
Tube Dimensions	13
Product Labeling	14
Bundle Dimensions and Labeling Information	14

General Product Information

Product Test Conditions

SnapLED 150 LEDs are tested and binned using a 20ms monopulse (MP) at 150mA drive current, junction temperature, T_j , of 25°C.

Part Number Nomenclature

Part numbers for SnapLED 150 follow the convention below:

A 1 S S – **B C C C D E 5 F G H J** 0 0

Where:

- B** – designates color (O=Red Orange)
- C C C** – designates minimum dominant wavelength (612=612nm)
- D** – designates the lens type (N=Narrow, W=Wide)
- E** – designates the binning condition (1=single binning 150mA, 8=dual binning 150mA and 5mA)
- F** – designates minimum flux bin (See Product Bin and Labeling section)
- G** – designates the flux bin range (3=3 subsequent flux bins including the minimum bin)
- H J** – designates forward voltage range in which H is the minimum V_f bin and J is the maximum V_f bin (See Product Bin and Labeling section)

Therefore, the following part number is used for a narrow angle SnapLED 150 Red Orange, 612nm minimum dominant wavelength, luminous flux range of 21 lumens to 36 lumens and forward voltage range of 2.07 volts to 2.79 volts:

A 1 S S – **O 6 1 2 N 1 5 N 3 A F** 0 0

Environmental Compliance

Lumileds LLC is committed to providing environmentally friendly products to the solid-state lighting market. SnapLED 150 is compliant to the European Union directives on the restriction of hazardous substances in electronic equipment, namely the RoHS Directive 2011/65/EU and REACH Regulation (EC) 1907/2006. Lumileds LLC will not intentionally add the following restricted materials to its products: lead, mercury, cadmium, hexavalent chromium, polybrominated biphenyls (PBB) or polybrominated diphenyl ethers (PBDE).

Performance Characteristics

Product Selection Guide

Table 1. Product selection for SnapLED 150 at 20ms MP, 150mA, $T_j=25^\circ\text{C}$.

COLOR	TYPICAL DOMINANT WAVELENGTH ^[1,2] (nm)	PART NUMBER
Red Orange	615	A1SS - O612x

Notes for Table 1:

1. Dominant wavelength is derived from the CIE 1931 Chromaticity diagram and represents perceived color.
2. Lumileds maintains a tolerance of $\pm 1\text{nm}$ for dominant wavelength measurements.

Optical Characteristics

Table 2. Typical optical characteristics for SnapLED 150 at 20ms MP, 150mA, $T_j=25^\circ\text{C}$.

PART NUMBER	TYPICAL TOTAL INCLUDED ANGLE ^[1] $\theta_{0.90V}$	TYPICAL VIEWING ANGLE ^[2] $2\theta_{1/2}$
A1SS - O612N	140°	45°
A1SS - O612W	110°	95°

Notes for Table 2:

1. Total angle at which 90% of total luminous flux is captured.
2. Viewing angle is the off axis angle from lamp center line where the luminous intensity is $\frac{1}{2}$ of the peak value.

Electrical Characteristics

Table 3. Typical electrical characteristics for SnapLED 150 at 20ms MP, 150mA, $T_j=25^\circ\text{C}$.

PARAMETER	PERFORMANCE
Forward Voltage, V_f	2.65V
Electrical Thermal Resistance, $R_{th-j-c\text{electr}}$ ^[1] (Maximum)	30°C/W
Real Thermal Resistance, $R_{th-j-c\text{real}}$ ^[2] (Maximum)	40°C/W
Temperature Coefficient of V_f , $I_f = 150\text{mA}$, $10^\circ\text{C} \leq T_c \leq 110^\circ\text{C}$	-3.7mV/°C

Notes for Table 3:

1. $R_{th-j-c\text{electr}}$: Electrical thermal resistance (junction to case).
2. $R_{th-j-c\text{real}}$: Real thermal resistance (junction to case) with wall plug efficiency included. Reference JESD51-51, JESD51-14, 4.1.3.

Absolute Ratings

Table 4. Absolute ratings for SnapLED 150.

PARAMETER	PERFORMANCE
Minimum DC Forward Current	5mA
Maximum DC Forward Current	200mA
Maximum Junction Temperature ^[1]	135°C
Operating Case Temperature at Test Current ^[1]	-40°C to 110°C
Operating Case Temperature at Maximum Current ^[1]	-40°C to 110°C
Storage Temperature	-55°C to 110°C
Soldering Temperature	Not applicable for clinching
Allowable Reflow Cycles	Not applicable for clinching
Minimum ESD performance ^[2]	8kV HBM (Class 3B), 1kV CDM (Class III)
Reverse Voltage (V _r)	-10V

Notes for 4:

1. Proper current derating must be observed to maintain junction temperature below the maximum, so that the LED is maintained below the maximum rated operating case temperature. SnapLEDs driven at or above the maximum rated operating case temperature may have shorter lifetime.
2. Measured using human body model (per ANSI/ESDA/JEDEC JS-001-2010) and charged device model (per JESD22-C101F).

Characteristic Curves

Spectral Power Distribution Characteristics

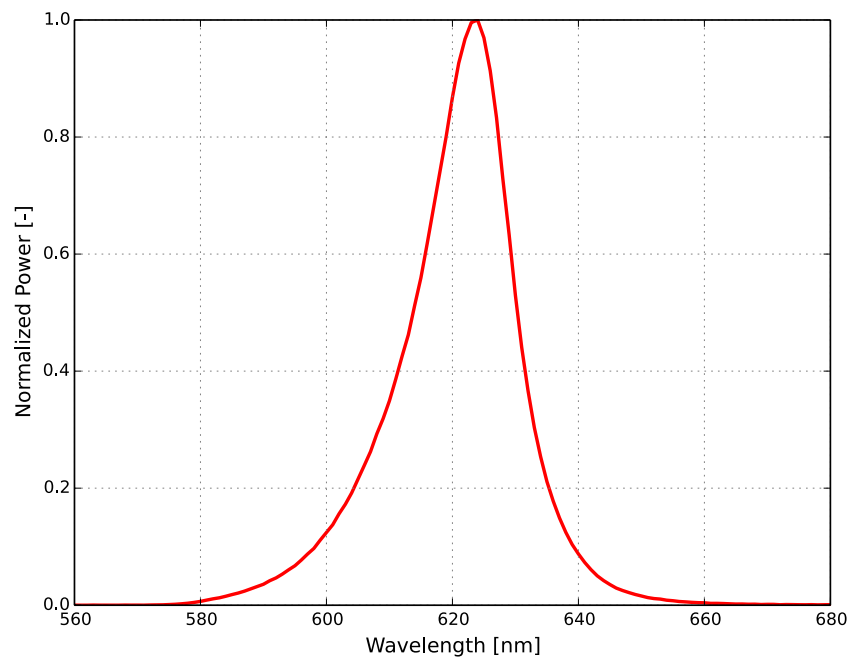

Figure 1: Typical normalized power vs. wavelength for SnapLED 150 at 20ms MP, 150mA, T_J=25°C.

Light Output Characteristics

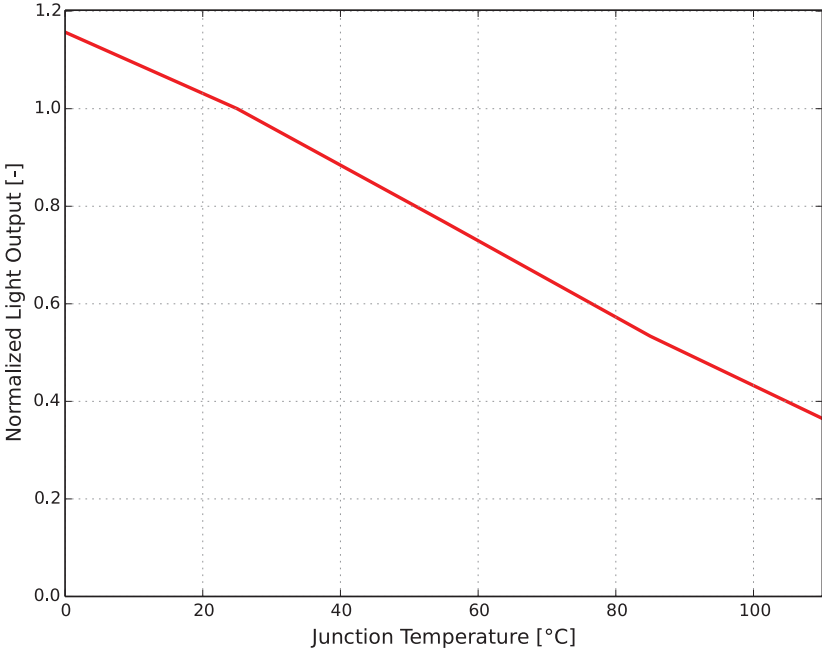

Figure 2: Typical normalized light output vs. junction temperature for SnapLED 150 at 20ms MP, 150mA.

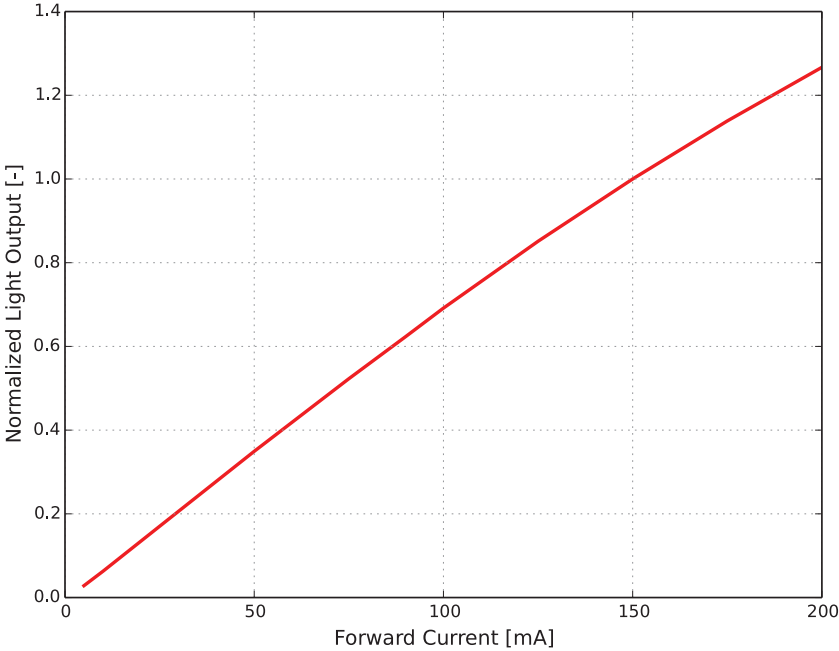

Figure 3: Typical normalized light output vs. forward current for SnapLED 150 at $T_j=25^\circ\text{C}$.

Forward Current Characteristics

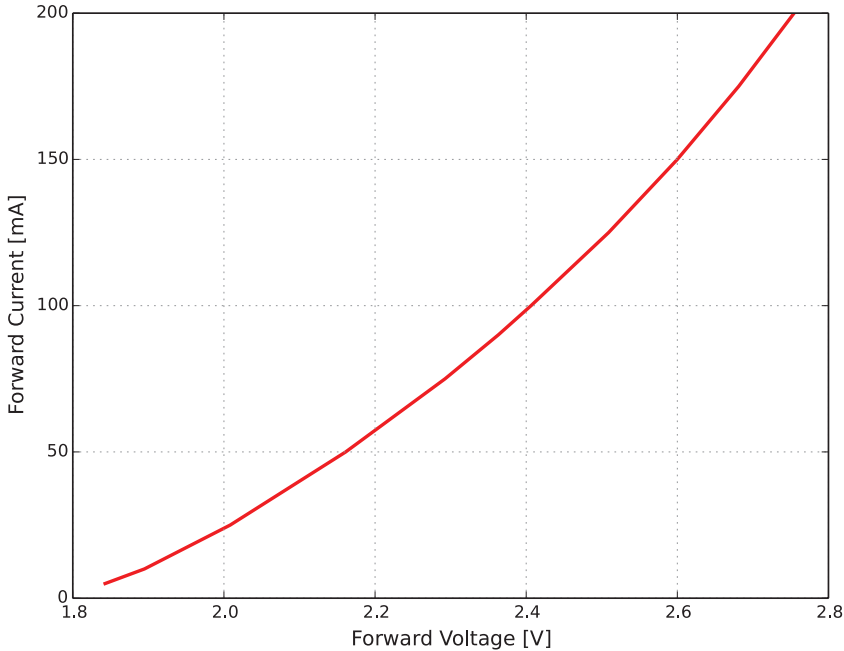

Figure 4a: Typical forward current vs. forward voltage for SnapLED 150 at $T_j=25^\circ\text{C}$.

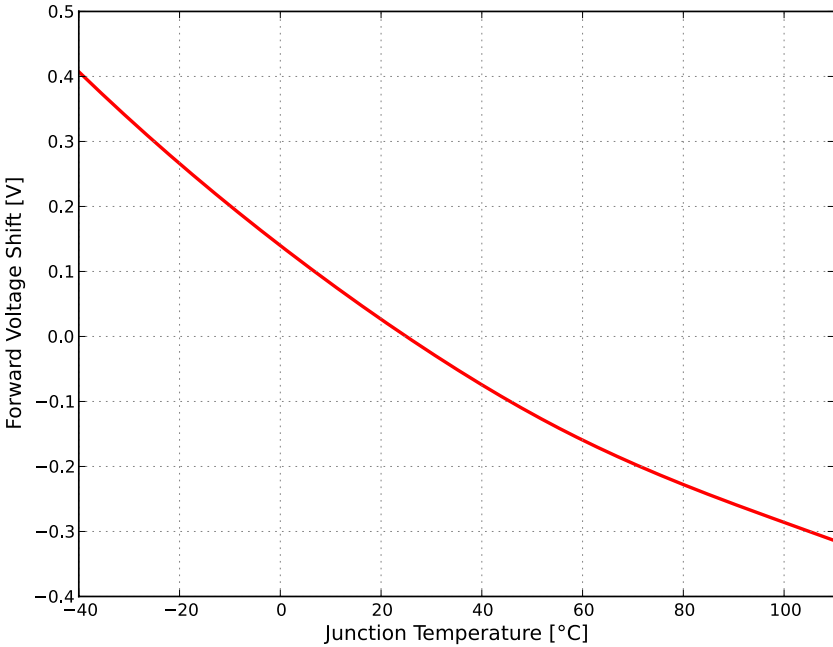

Figure 4b: Typical forward voltage vs. junction temperature for SnapLED 150 at 150mA, 20ms MP.

Radiation Pattern Characteristics

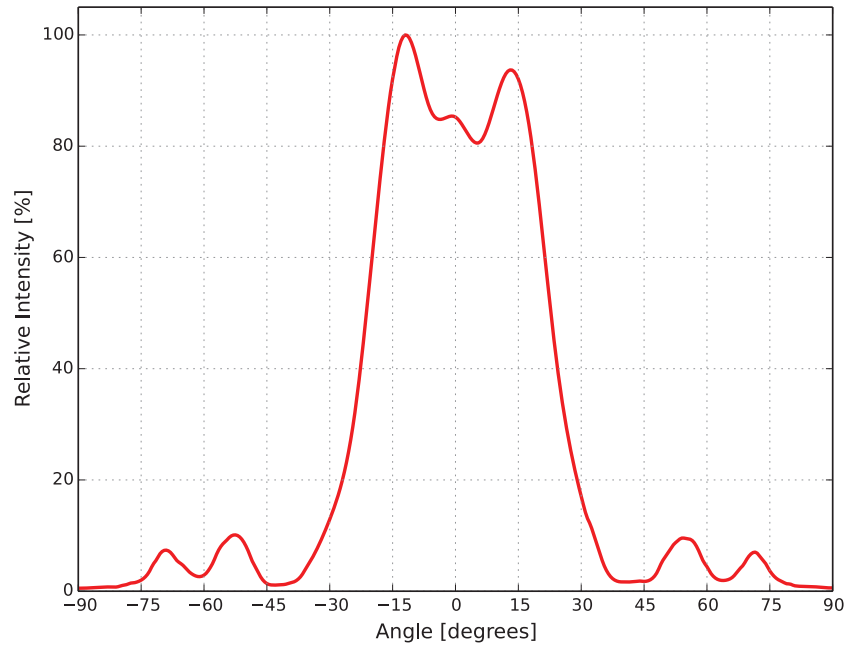

Figure 5a: Typical radiation pattern for SnapLED 150 narrow lens at 20ms MP, 150mA.

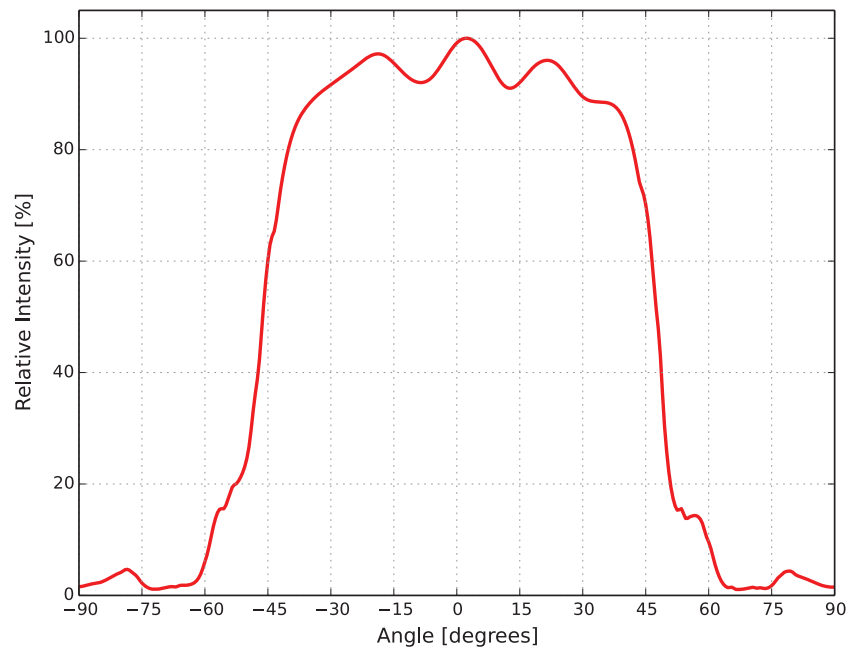

Figure 5b: Typical radiation pattern for SnapLED 150 wide lens at 20ms MP, 150mA.

Operating Limits Characteristics

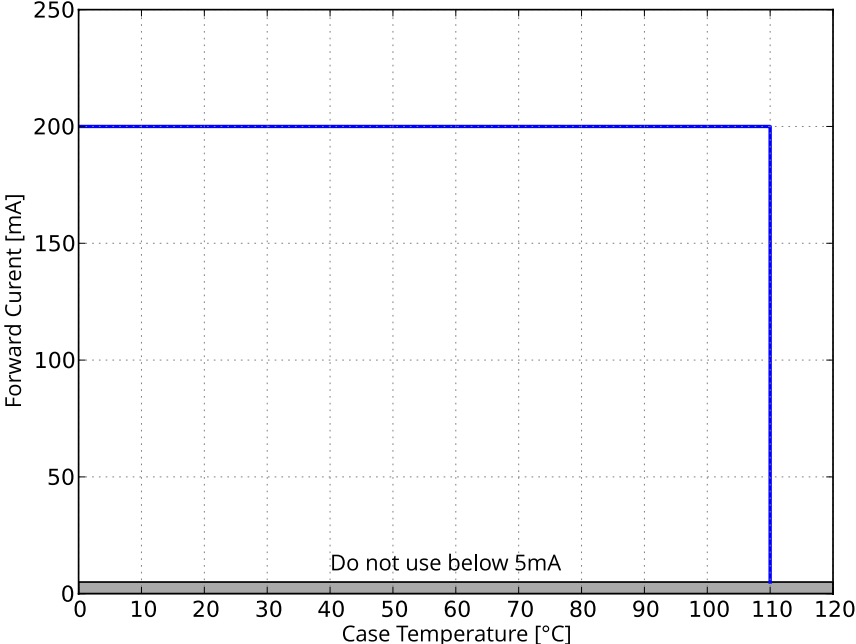

Figure 6: Maximum forward current vs. case temperature for SnapLED 150.

Product Bin and Labeling Definitions

Designing with SnapLED

Flux bins supportable for car programs depend on product color and program start- and end-of-production date. Flux roadmaps by year and product color are maintained and available from the sales representative. Please contact local sales representative to request the flux bin range with best supportability for program timing.

Decoding Product Bin Labeling

In the manufacturing of semiconductor products, there are variations in performance around the average values given in the technical datasheets. For this reason, Lumileds bins the LED components for luminous flux, color and forward voltage.

SnapLED 150 single binned LEDs are labeled using a 3-digit alphanumeric CAT code following the format below:

A B C

- A** – designates luminous flux bin at 150mA (example: M=18 lumens to 21 lumens)
- B** – designates color code (example: 3=612nm to 618nm)
- C** – designates forward voltage bin at 150mA (example: B=2.19V to 2.31V)

SnapLED 150 dual binned LEDs are labeled using a 5-digit CAT code following the format below.

A b C D e

- A** – designates luminous flux bin at 150mA (example: M=18 lumens to 21 lumens)
- b** – designates luminous flux bin at 5mA (example: m=0.60 lumens to 0.72 lumens)
- C** – designates color code (example: 3=612nm to 618nm)
- D** – designates forward voltage bin at 150mA (example: B=2.19V to 2.31V)
- e** – designates forward voltage bin at 5mA (example: b=1.72V to 1.78V)

Luminous Flux Bins

Table 5 lists the standard photometric luminous flux bins for SnapLED 150 LEDs. Product availability in a particular bin varies by color and platform start of production date. Contact local sales representative for best supportability of programs.

Table 5a. Luminous flux bin definitions for SnapLED 150 at 20ms MP, 150mA, $T_j=25^\circ\text{C}$.

BIN	LUMINOUS FLUX (lm)	
	MINIMUM	MAXIMUM
M	18.0	21.0
N	21.0	25.0
P	25.0	30.0
R	30.0	36.0

Notes for Table 5a:

1. Lumileds maintains a tolerance of $\pm 10\%$ on luminous flux measurements.

Table 5b. Luminous flux bin definitions for SnapLED 150 at 20ms MP, 5mA, T_j=25°C.

BIN	LUMINOUS FLUX (lm)	
	MINIMUM	MAXIMUM
h	0.42	0.50
j	0.50	0.60
m	0.60	0.72
n	0.72	0.86
p	0.86	1.02
r	1.02	1.22

Notes for Table 5b:

1. Lumileds maintains a tolerance of ±10% on luminous flux measurements.
2. Applies to dual binning option only.

Table 5c. Luminous flux bin pairing for SnapLED 150 at 20ms MP, 150mA and 5mA, T_j=25°C.

BIN	BIN PAIRING	MINIMUM LUMINOUS FLUX (lm)	MAXIMUM LUMINOUS FLUX (lm)
150mA	5mA		
M	h, j, m	0.42	0.72
N	j, m, n	0.50	0.86
P	m, n, p	0.60	1.02
R	n, p, r	0.72	1.22

Notes for Table 5c:

1. Applies to dual binning option only.

Color Codes

Table 6. Color code definitions for SnapLED 150 at 20ms MP, 150mA, T_j=25°C.

CODE	DOMINANT WAVELENGTH (nm)	
	MINIMUM	MAXIMUM
3	612	618

Notes for Table 6:

1. Lumileds maintains a tolerance of ±1nm on dominant wavelength measurements.

Forward Voltage Bins

Table 7a. Forward voltage bin definitions for SnapLED 150 at 20ms MP, 150mA, T_j=25°C.

BIN	FORWARD VOLTAGE (V)	
	MINIMUM	MAXIMUM
A	2.07	2.19
B	2.19	2.31
C	2.31	2.43
D	2.43	2.55
E	2.55	2.67
F	2.67	2.79

Notes for Table 7a:

1. Lumileds maintains a tolerance of ±0.06V on forward voltage measurements.

Table 7b. Forward voltage bin definitions for SnapLED 150 at 20ms MP, 5mA, $T_j=25^\circ\text{C}$.

BIN	FORWARD VOLTAGE (V)	
	MINIMUM	MAXIMUM
a	1.66	1.72
b	1.72	1.78
c	1.78	1.84
d	1.84	1.90
e	1.90	1.96
f	1.96	2.02

Notes for Table 7b:

1. Lumileds maintains a tolerance of $\pm 0.06\text{V}$ on forward voltage measurements.
2. Applies to dual binning option only.

Table 7c. Forward voltage bin pairing for SnapLED 150 at 20ms MP, 150mA and 5mA, $T_j=25^\circ\text{C}$.

BIN	MINIMUM FORWARD VOLTAGE (V)	MAXIMUM FORWARD VOLTAGE (V)	PAIRING BIN	MINIMUM FORWARD VOLTAGE (V)	MAXIMUM FORWARD VOLTAGE (V)
	150mA			5mA	
A	2.07	2.19	a	1.66	1.72
B	2.19	2.31	a, b	1.66	1.78
C	2.31	2.43	a, b, c	1.66	1.84
D	2.43	2.55	a, b, c, d	1.66	1.90
E	2.55	2.67	a, b, c, d, e	1.66	1.96
F	2.67	2.79	a, b, c, d, e, f	1.66	2.02

Notes for Table 7b:

1. Lumileds maintains a tolerance of $\pm 0.06\text{V}$ on forward voltage measurements.
2. Applies to dual binning option only.

Mechanical Dimensions

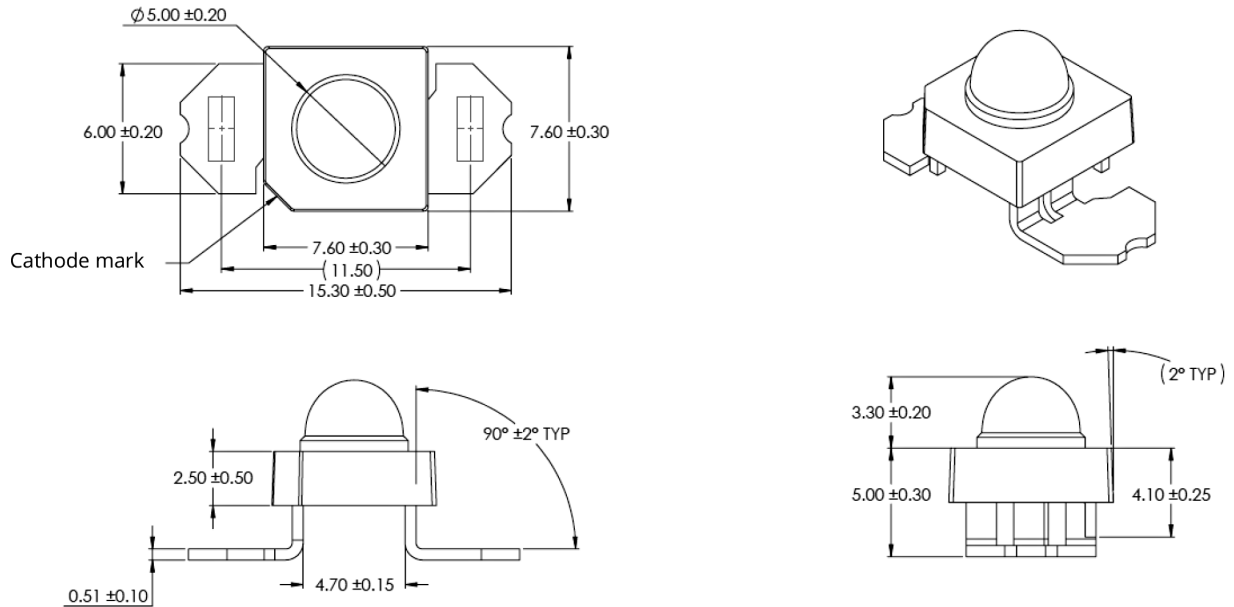

Figure 7a: Mechanical dimensions for SnapLED 150 narrow lens.

Notes for Figure 7a:

1. Drawings are not to scale.
2. All dimensions are in millimeters.

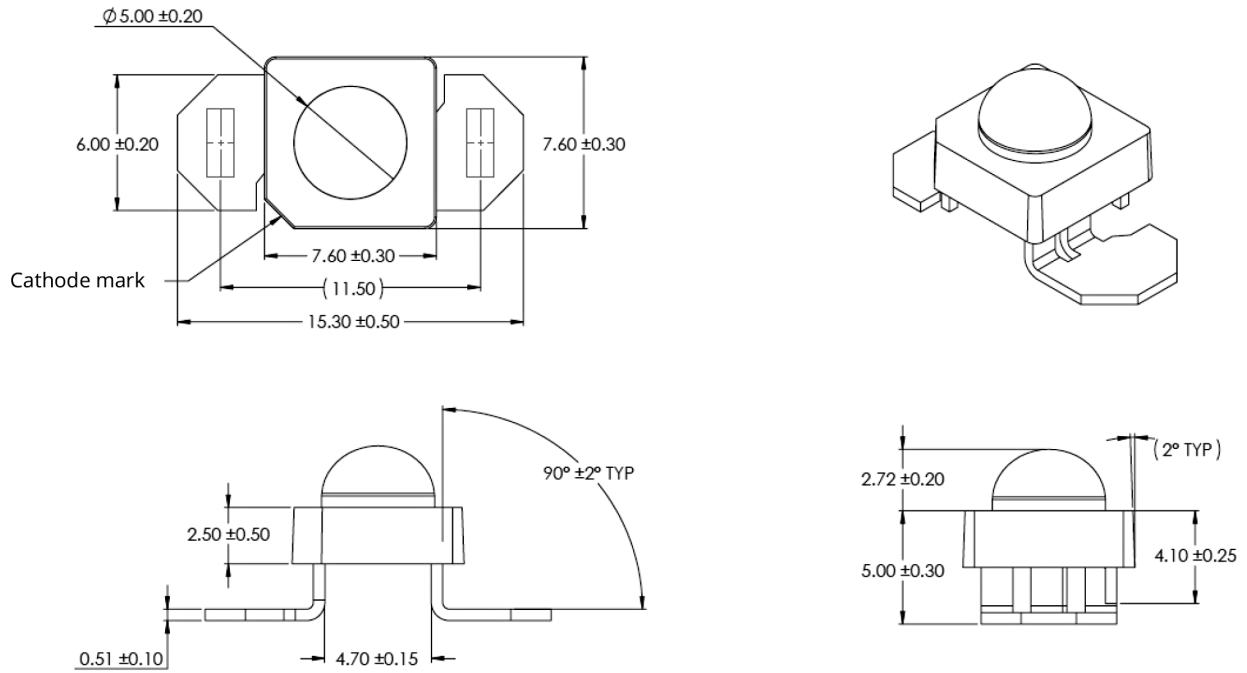

Figure 7b: Mechanical dimensions for SnapLED 150 wide lens.

Notes for Figure 7b:

1. Drawings are not to scale.
2. All dimensions are in millimeters.

Thermal Resistance Characteristics

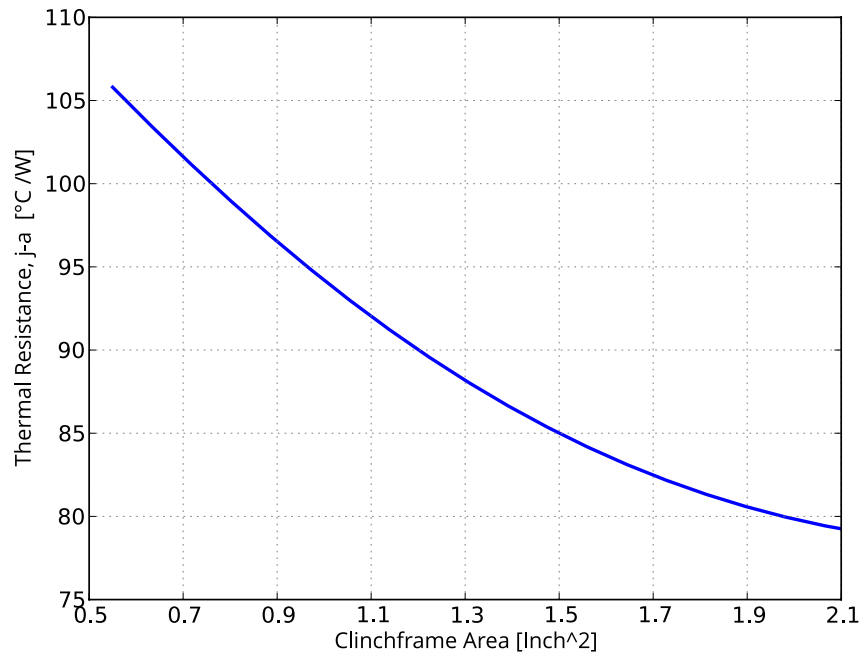

Figure 8: Approximate total thermal resistance vs. clinch frame area per anode for SnapLED 150.

Packaging Information

SnapLED 150 LEDs are packaged in tubes for use with automatic insertion equipment then shrink wrapped into bundles and shipped in boxes measuring (49.2cm x 20.1cm x 11.8cm).

Each tube contains a specified number of LEDs. The LEDs in each tube come from a single category code, ensuring they are all well-matched for light output, color, and forward voltage.

Each tube contains a rubber stopper at one end.

Table 8. Number of LEDs per tube for SnapLED 150.

TOTAL UNITS per TUBE	TOTAL TUBES per BUNDLE	TOTAL UNITS per BUNDLE/BOX
60	10	600

Tube Dimensions

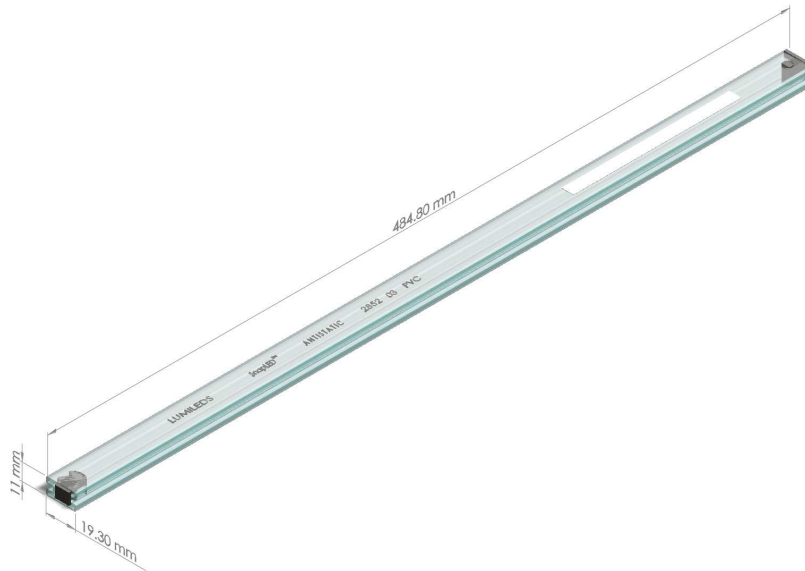

Figure 9: Tube dimensions for SnapLED 150.

Product Labeling

The tube label has both alphanumeric and bar code information. The bundles have printed information providing part numbers with CAT codes that indicate luminous flux, color and forward voltage bins.



Figure 10: Example of SnapLED LED tube label.

Bundle Dimensions and Labeling Information

Product bundles include the following information: Lumileds part number, 3 or 5 digit category code, lot code (for Lumileds internal use), quantity, and the date code range.

Each bundle of tubes will have a bundle label as shown in Figure 11b. The label indicates the Part number of SnapLED Products with CAT Code and the quantity of the products inside the box.

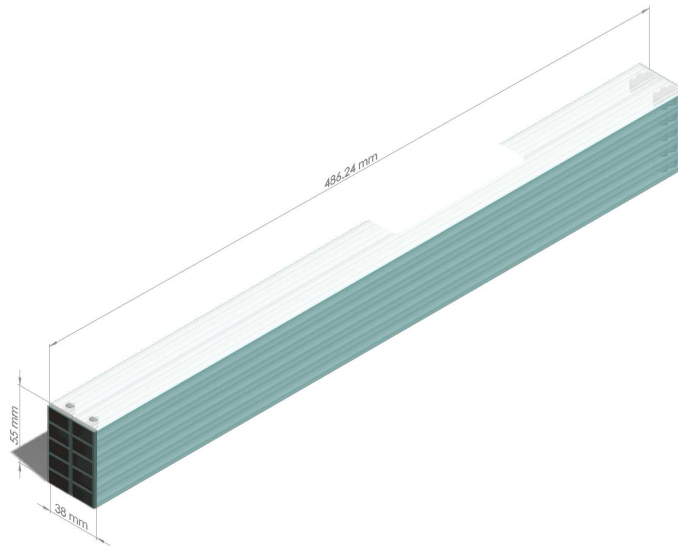

Figure 11a: Bundle dimensions for SnapLED 150.

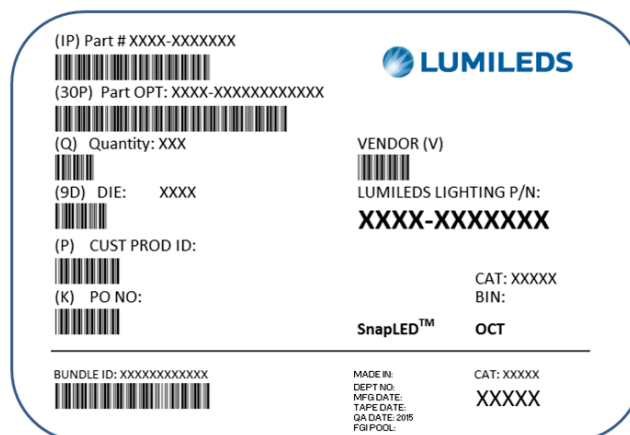

Figure 11b: Example of box and bundle label for SnapLED 150.

About Lumileds

Lumileds is the global leader in light engine technology. The company develops, manufactures and distributes groundbreaking LEDs and automotive lighting products that shatter the status quo and help customers gain and maintain a competitive edge. With a rich history of industry “firsts,” Lumileds is uniquely positioned to deliver lighting advancements well into the future by maintaining an unwavering focus on quality, innovation and reliability.

To learn more about our portfolio of light engines, visit lumileds.com.



©2015 Lumileds Holding B.V. All rights reserved.
LUXEON is a registered trademark of the Lumileds Holding B.V.
in the United States and other countries.

lumileds.com

Neither Lumileds Holding B.V. nor its affiliates shall be liable for any kind of loss of data or any other damages, direct, indirect or consequential, resulting from the use of the provided information and data. Although Lumileds Holding B.V. and/or its affiliates have attempted to provide the most accurate information and data, the materials and services information and data are provided “as is,” and neither Lumileds Holding B.V. nor its affiliates warrants or guarantees the contents and correctness of the provided information and data. Lumileds Holding B.V. and its affiliates reserve the right to make changes without notice. You as user agree to this disclaimer and user agreement with the download or use of the provided materials, information and data.